

Travel Limit Adjustment— I. UP Limit

WARNING

To prevent SERIOUS INJURY or DEATH from improper Force Adjustment:

- YOU CANNOT adjust force manually to compensate for binding or sticking of the garage door. Call a qualified garage door service person to make necessary adjustments in case of binding.
- YOU CANNOT manually increase the force required for closing the door.
- After ANY adjustments, Safety Reverse Test MUST be performed to ensure the door reverses on contact with a 1.5" high object (2x4 laid flat).

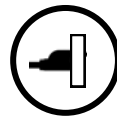

NOTICE: This opener will not work until you set the travel limits and the auto force adjustment. You must follow all steps on pages 16,17,18.

I. Setting UP Limit

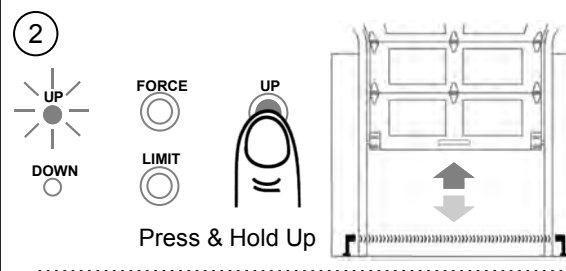
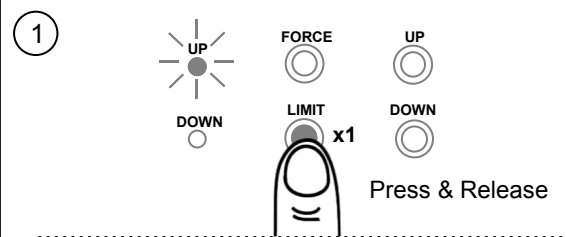

③ *** DO NOT HIT STOP BOLT ***

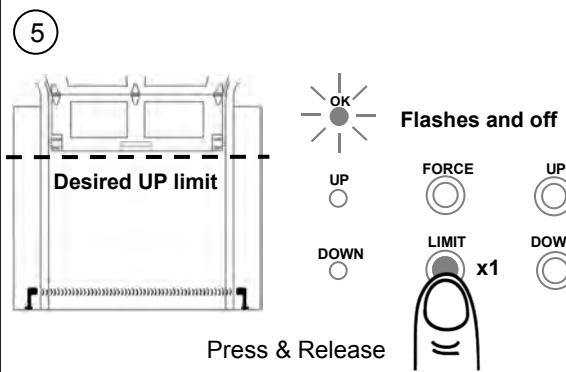
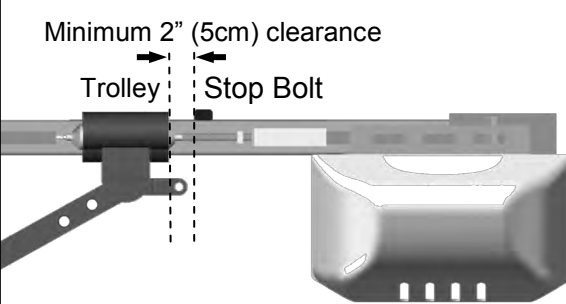

About Travel UP Limit Adjustment

Travel "UP" Limit Adjustment regulates the fully-open (UP limit) position. This step will program how far the opener will open the garage door.

Make sure the trolley is engaged, photo eyes are installed P.14 and photo eyes are aligned P.15 before proceeding with adjustments.

I. Setting Travel UP Limit

1. Press and Release "LIMIT" button **ONCE** to enter Travel Limit Adjustment. "UP" indicator (green) will turn on*.
*NOTE: Once you have pressed and released the "Limit" button, the "UP" light will stay on for 10 seconds. You must press & hold the "UP" button within 10 seconds to begin programming. If the "UP" light turns off before pressing and holding the "UP" you will need to start over.
2. **With green indicator on**, press & hold the "UP" button, the door will travel up. You may use both "UP" or "DOWN" buttons to inch-adjust the door to the desired UP limit position.
3. **DO NOT HIT STOP BOLT!** There is a minimum 2" (5cm) gap between Trolley and Stop Bolt.
4. Make sure there is enough clearance for your vehicle(s), to enter and exit the garage door.
5. Once the door is at the desired UP limit position, press and release "LIMIT" button once, "OK" indicator (orange) flashes and goes off. The UP limit is set.

Continue to page 17 for down limit



Travel Limit Adjustment— II. DOWN Limit

WARNING

To prevent **SERIOUS INJURY** or **DEATH** from improper Force Adjustment:

- **YOU CANNOT** adjust force manually to compensate for binding or sticking of the garage door. Call a qualified garage door service person to make necessary adjustments in case of binding.
- **YOU CANNOT** manually increase the force required for closing the door.
- After **ANY** adjustments, Safety Reverse Test **MUST** be performed to ensure the door reverses on contact with a 1.5" high object (2x4 laid flat).



NOTICE: This opener will not work until you set the travel limits and the auto force adjustment. You must follow all steps on pages 16,17,18

II. Setting DOWN Limit

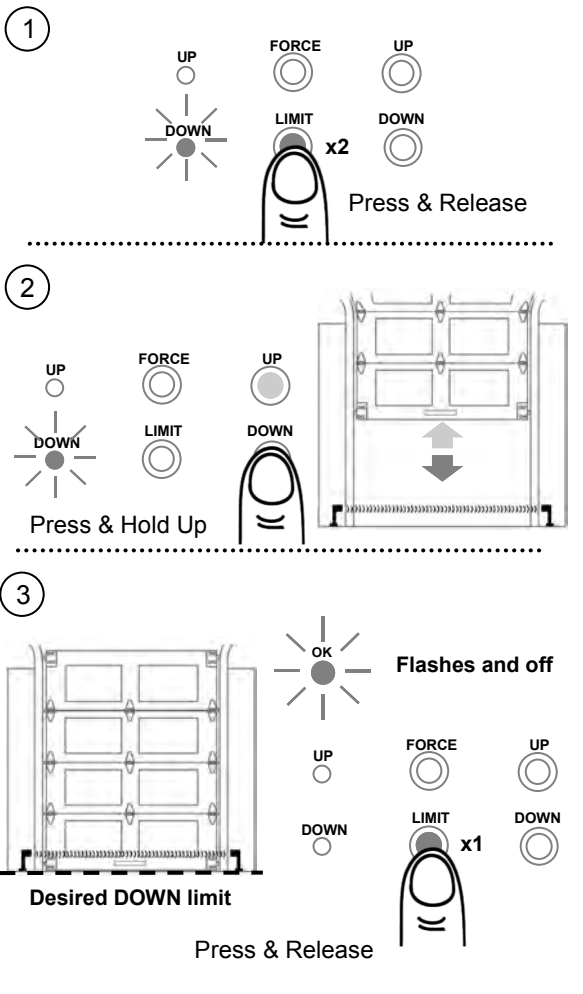

CAUTION: WHILE SETTING THE DOWN LIMIT, CAREFULLY WATCH DOOR TRAVEL DISTANCE. RELEASE BUTTON WHEN THE DOOR MAKES CONTACT WITH THE GROUND!

About Travel DOWN Limit Adjustment

Travel “DOWN” Limit Adjustment regulates the fully-closed (DOWN limit) position. This step will program how far the opener will close the garage door.

Make sure the trolley is engaged, photo eyes are installed P.14 and photo eyes are aligned P.15 before proceeding with adjustments.

I. Setting Travel DOWN Limit

1. Press and Release “LIMIT” button **TWICE** to enter Travel Limit Adjustment. “DOWN” indicator (red) will turn on*.

*NOTE: Once you have pressed and released the “Limit” button twice, the “DOWN” light will stay on for 10 seconds. You must press & hold the “DOWN” button within 10 seconds to begin programming. If the “DOWN” light turns off before pressing and holding the “DOWN” you will need to start over.
2. **With red indicator on**, press & hold the “DOWN” button, the door will travel down. You may use both “UP” or “DOWN” buttons to inch-adjust the door to the desired DOWN limit position.
3. Once the door is at the desired DOWN limit position, press and release “LIMIT” button once, “OK” indicator (orange) flashes and goes off. The DOWN limit is set.

Both “UP” and “DOWN” (green and red) indicators are now on, indicating that both UP and DOWN limits are set, and the opener is ready for Auto Force Adjustment, see Page 18.

Continue to page 18 for force adjustment

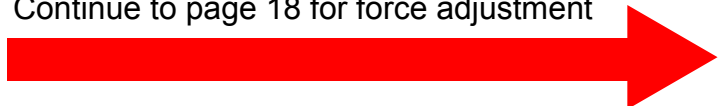

Auto Force Adjustment

WARNING

To prevent **SERIOUS INJURY** or **DEATH** from improper Force Adjustment:

- YOU CANNOT adjust force manually to compensate for binding or sticking of the garage door. Call a qualified garage door service person to make necessary adjustments in case of binding.
- YOU CANNOT manually increase the force required for closing the door.
- After ANY adjustments, Safety Reverse Test **MUST** be performed to ensure the door reverses on contact with a 1.5" high object (2x4 laid flat).



NOTICE: This opener will not work until you set the travel limits and the auto force adjustment. You must follow all steps on pages 16,17,18

Auto Force Adjustment

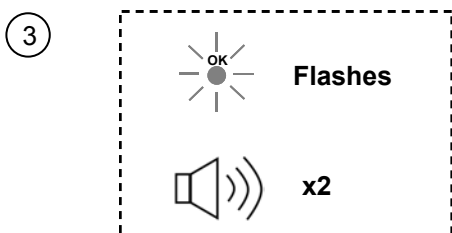
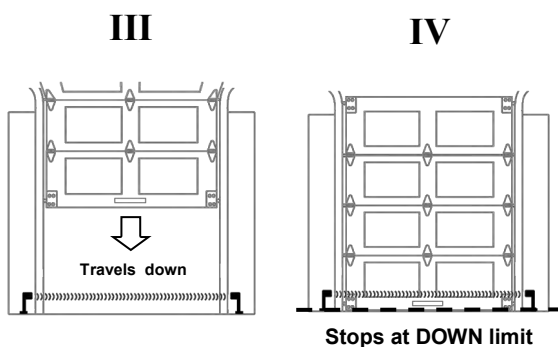
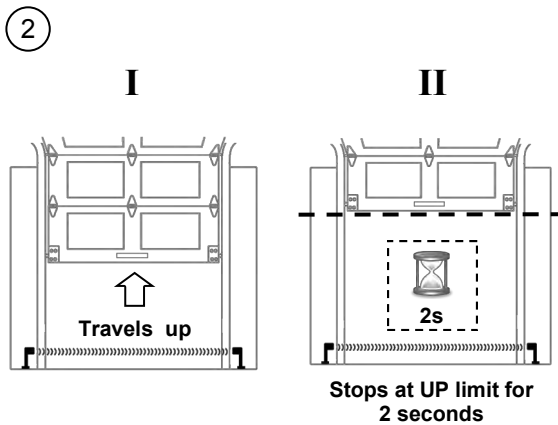
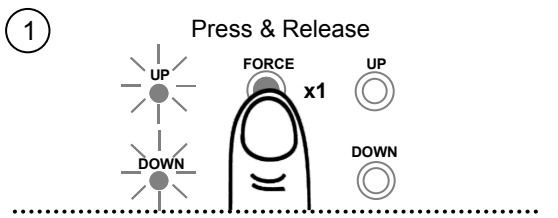

Following limit-setting, the unit is now ready to automatically adjust the forces for opening and closing the door. The door will automatically open and close. The opener is measuring the weight of the door and the force that is required to open and close the garage door. Proceed with the following steps to complete adjustment.

Make sure the trolley is engaged, photo eyes are installed P.14 and photo eyes are aligned P.15 before proceeding with adjustments.

1. With both "UP" and "DOWN" indicators on after Travel Limit Adjustment, press and release the "FORCE" button once to enter Auto Force Adjustment.
2. The door will travel up **automatically** (I) and stop at UP limit for 2 seconds (II). Door will then travel down **automatically** (III) and stop at down limit (IV).
3. The "OK" indicator (orange) will flash with beeps, the Auto Force Adjustment is completed.

The opener is now programmed and ready for operation. Continue to page 19 to install wall panel then page 20 to program the remotes.

Continue to page 19 for wall panel installation



How to Clear and Reset the limits and the force

1. Press and hold "LIMIT" button for about 5-7 seconds. The dome light will come on or go off. Release the limit button
2. The unit's dome light will then flash 5 times
3. The unit is returned to factory default and is ready for programming limits and force.

Connecting Wall Panel

WARNING

To prevent **SERIOUS INJURY** or **DEATH** from electrocution:

- Power **MUST NOT** be connected until instructed.

To prevent **SERIOUS INJURY** or **DEATH** from using the Wall Panel or Push Button and a closing door:

- Install the Wall Panel or Push Button within sight of the door at a minimum height of 5 feet (1.5m) above the floor. Make sure it is out of the reach of children and moving parts of door and hardware.
- **NEVER** permit children to access the Wall Panel, Push Button or remote Transmitters.
- Operate the door **ONLY** when it is adjusted properly with no obstructions present and is in clear sight.
- **ALWAYS** keep a moving door in sight until it's completely closed.
- **NEVER** cross the path of a moving door.



NOTICE: This opens wall button will not work until you set the travel limits and the auto force adjustment. You must follow all steps located on pages 16,17,18.

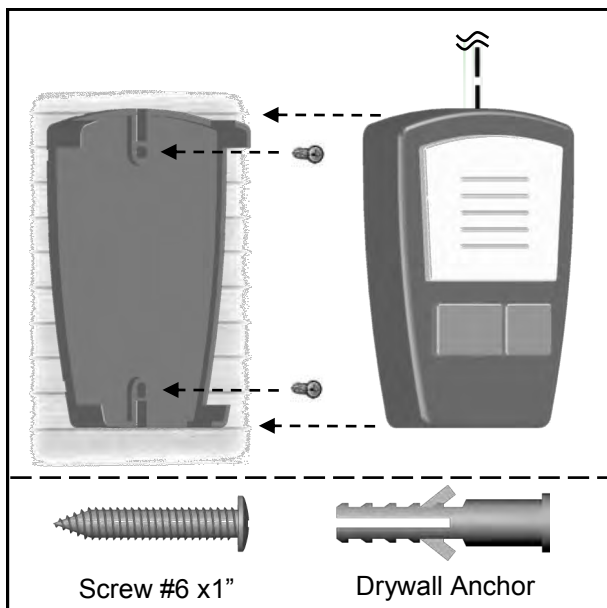

Fig. 1

The Wall Panel is a wired, illuminated door control placed inside your garage.

To install the Wall Panel:

1. Inside your garage, install the back plate of the Wall Panel within sight of the door at a minimum height of 5 feet (1.5m) off the ground. Ensure it is installed out of the reach of children and free from the moving parts of the door and hardware.
2. Fasten it to a solid surface with 1" screws. If attaching to drywall or other hollow surface, drill 3/16" holes and use the provided Drywall Anchors.
3. Snap the Wall Panel onto the back plate.

To Connect the Wall Panel to the Opener

Connect the plug from the Wall Panel to the "Wall Panel" outlet on the rear of the Opener, as shown in Fig.2.

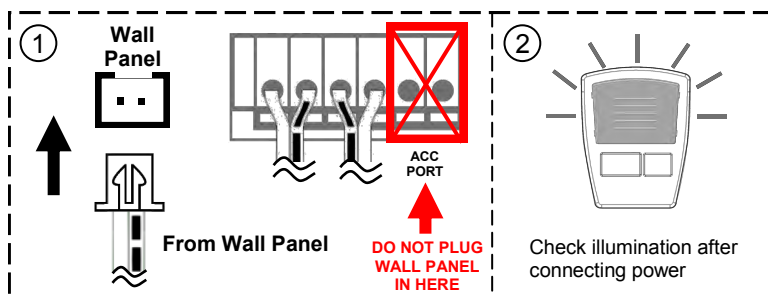

Fig. 2

Using the Wall Panel

(ONLY after installation is completed)



Door — Press and release to access the door



Light — Turns the courtesy light On/Off

Vacation Lock

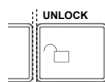

Unlock — Sliding to the left **ACTIVATES** all remotes, wall panel and accessories and dims the red illuminated wall panel main button.

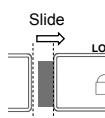

Lock — Sliding to the right **DEACTIVATES** all remotes, wall panel and accessories and brightens the red illuminated wall panel main button.

